













# ASSEMBLY INSTRUCTION

Model : CHARLIE-BLUE/BLACK/WHITE-KB-HB/FB

Description : KING BED HEADBOARD WITH LED  
& FOOTBOARD

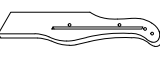
Thank you for purchasing this quality product. Be sure to check all packing material carefully for small parts that may have come loose inside the carton during shipment.

PART LIST :				HARDWARE LIST :				
No.	Description	Diagram	Quantity	No.	Description	Diagram	Size	Quantity
A	HEADBOARD PANEL		1	G	JCBC SCREW		M6 x 45mm	12
B	LEFT HEADBOARD LEG		1	H	SPRING WASHER		M6 x 13mm	12
C	RIGHT HEADBOARD LEG		1	I	FLAT WASHER		M6 x 13mm	4
D	FOOTBOARD PANEL		1	J	FLAT WASHER		M6 x 19mm	8
E	LEFT FOOTBOARD LEG		1	K	WOOD PLUG			4
F	RIGHT FOOTBOARD LEG		1	L	ALLEN KEY		M4	1
				M	ADAPTOR			1

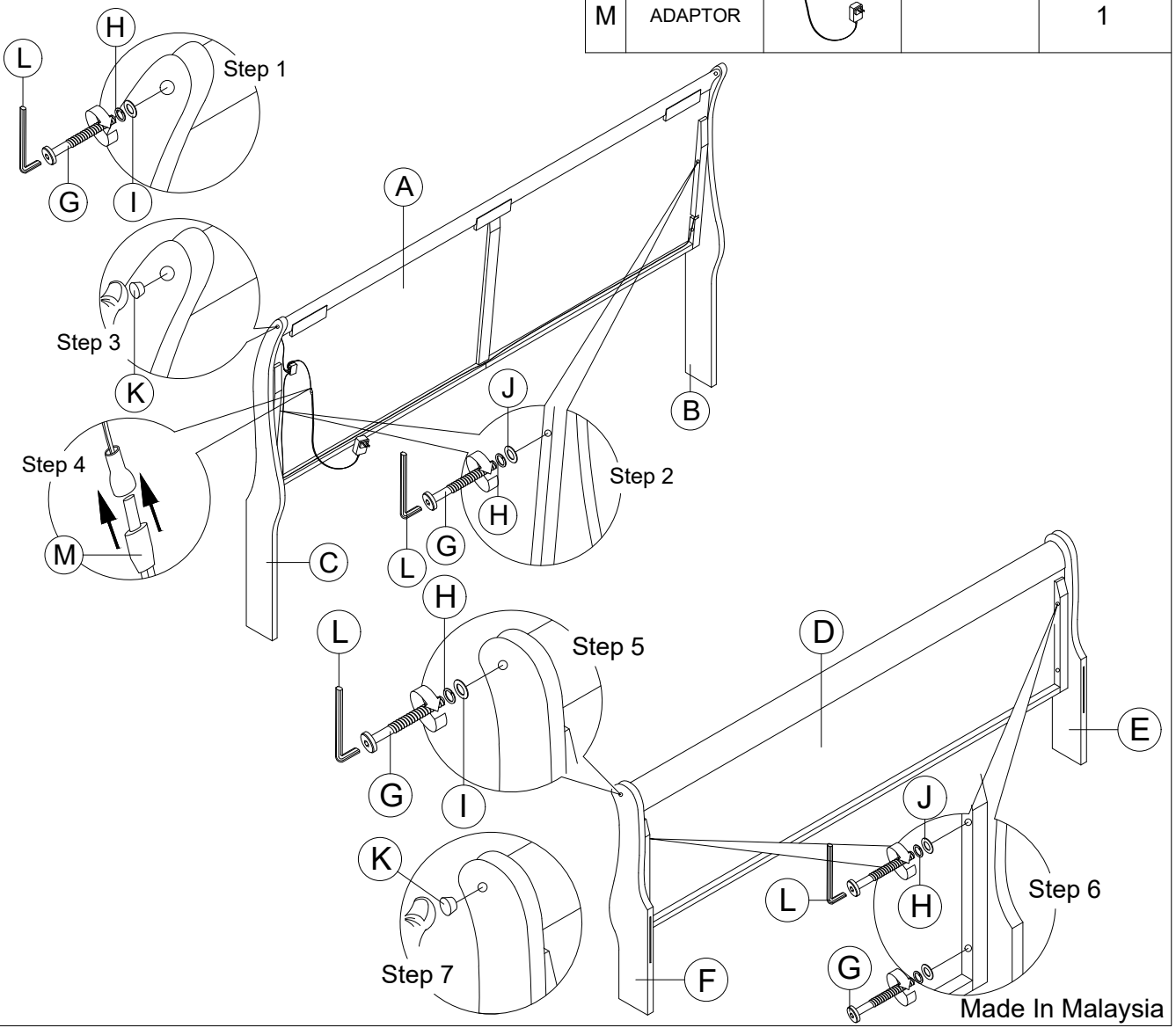

# ASSEMBLY INSTRUCTION

Model : CHARLIE-BLUE/BLACK/WHITE-KB-HB/FB-KB-SR

Description : KING BED HEADBOARD WITH LED & FOOTBOARD-SIDE RAILS

Thank you for purchasing this quality product. Be sure to check all packing material carefully for small parts that may have come loose inside the carton during shipment.

## PART LIST :

No.	Description	Diagram	Quantity
A	HEADBOARD WITH LED		1
B	FOOTBOARD		1
C	SIDE RAIL		2
D	WOODEN SLAT		3
E	WOODEN SUPPORT		6

## HARDWARE LIST :

No.	Description	Diagram	Size	Quantity
F	CB SCREW		M4 x 32mm	6
G	SCREW DRIVER (*)			1

(\*) The manufacturer does not provide item G.

Led Touch Sensor :  
 i) Switch on  
 ii) Lighter  
 iii) More lighter  
 iv) Switch off

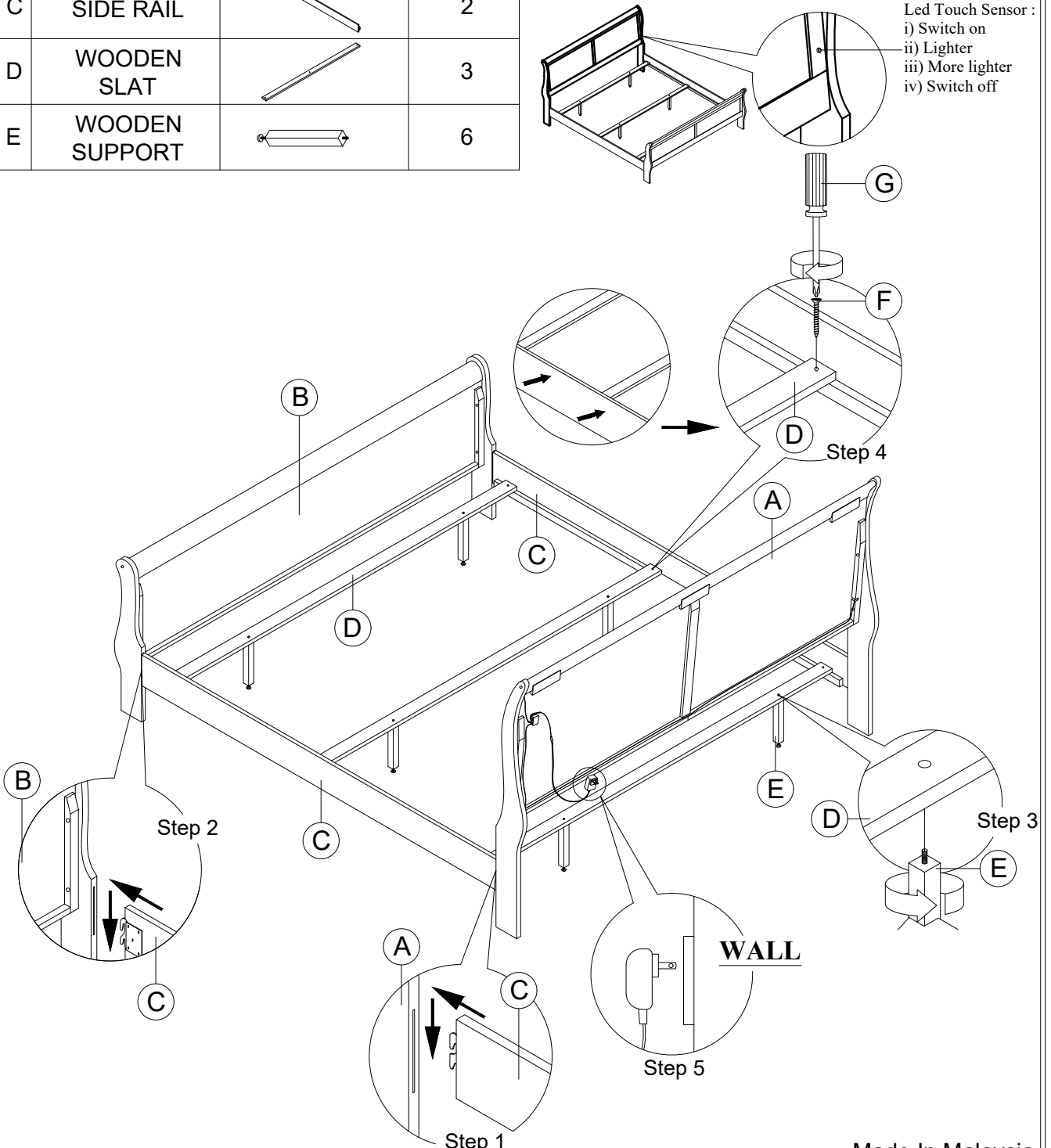

Made In Malaysia

CHARLIE KING BED