



ASSEMBLY INSTRUCTION

GLOBAL FURNITURE USA





MODEL : 9749 PARIS
DESCRIPTION : PARIS-CH-AL

Thank you for purchasing this quality product. Be sure to check all packing material carefully for small parts which may have loose inside the carton during shipment. Identify and count all parts and compare with the parts list below.

PART LIST#

NO	DRAWING	DESCRIPTION	QTY
A		Chest	1pc
B		Bun Foot	2pcs
C		Metal Leg	2pcs

HARDWARE LIST#

NO	NAME	PART	QTY
1	Allen Key		1pc
2	JCBC - M6 x 20mm		4pcs
3	M6 Spring Washer		4pcs
4	M6 Flat Washer		4pcs

Bun Foot cover



Remove Bun Foot cover before assemble.

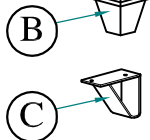

Remove Bun Foot carton located in the drawer of the casegood. Remove and unwrap each foot.

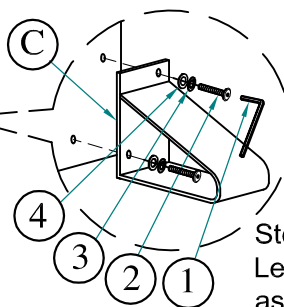
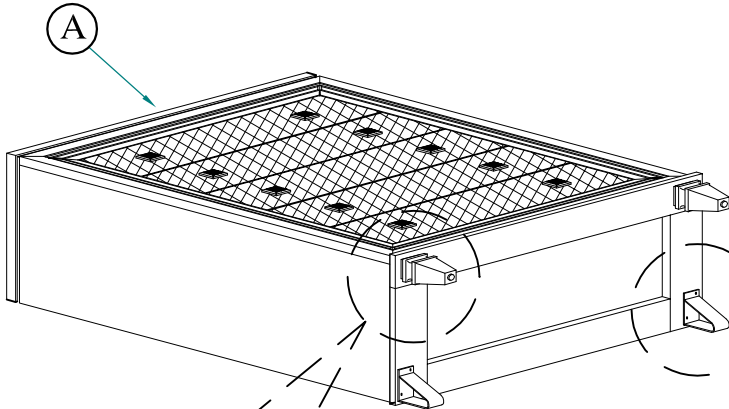
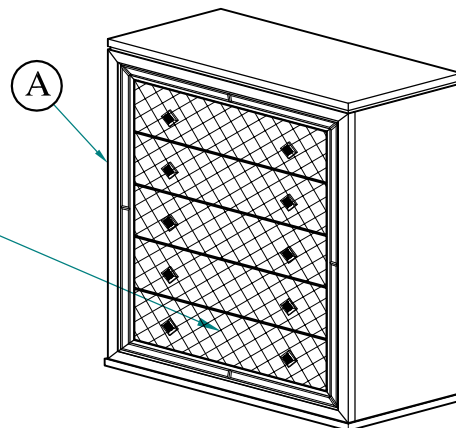

Step 2 : Secure the (C) Metal Leg to the bottom of (A) Chest as a diagram shown.

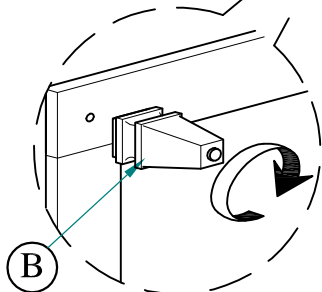



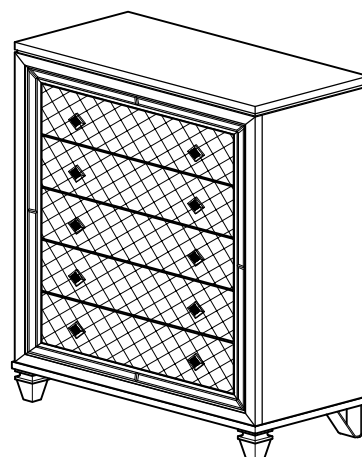

Step 1 : Secure the (B) Bun Foot to the bottom of (A) Chest as a diagram shown.



Assembly completed

HARDWARE LIST (ANTI TIPPING)

NO	NAME	PART	QTY
A	Bracket		2pcs
B	Tie Wrap		1pc
C	Long Screw		1pc
D	Short Screw		1pc

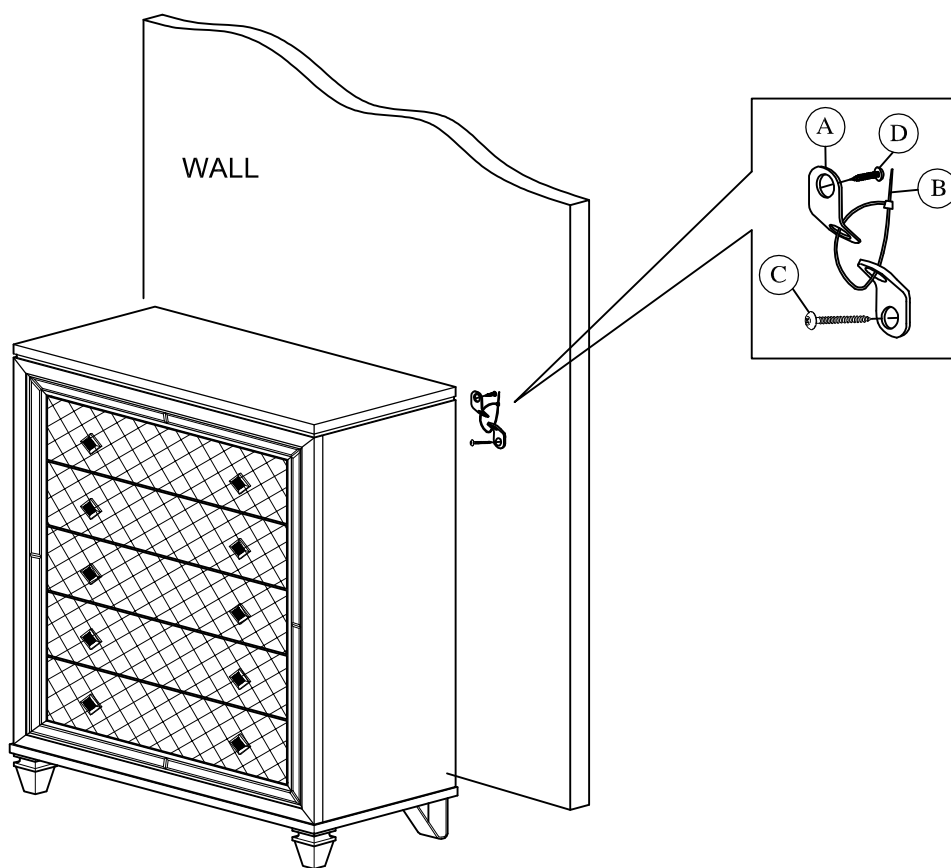

Assembly completed