



Grandstream Networks, Inc.

1297 Beacon Street, 2nd Floor  
Brookline, MA 02446. USA  
Tel : +1 (617) 566 – 9300  
Fax: +1 (617) 249 – 1987

[www.grandstream.com](http://www.grandstream.com)

## **GXP2120/2110 Enterprise IP Phone Quick Start Guide**

For Warranty and RMA information, please visit [www.grandstream.com](http://www.grandstream.com)

The GXP2120/2110 is not pre-configured to support or carry emergency calls to any type of hospital, law enforcement agency, medical care unit (“Emergency Service(s)”) or any other kind of Emergency Service. You must make additional arrangements to access Emergency Services. It is Your responsibility to purchase SIP-compliant Internet telephone service, properly configure the GXP2120/2110 to use that service, and periodically test your configuration to confirm that it works as You expect. If You do not do so, it is Your responsibility to purchase traditional wireless or landline telephone services to access Emergency Services.

GRANDSTREAM DOES NOT PROVIDE CONNECTIONS TO EMERGENCY SERVICES VIA THE GXP2120/2110. NEITHER GRANDSTREAM NOR ITS OFFICERS, EMPLOYEES OR AFFILIATES MAY BE HELD LIABLE FOR ANY CLAIM, DAMAGE, OR LOSS, AND YOU HEREBY WAIVE ANY AND ALL SUCH CLAIMS OR CAUSES OF ACTION ARISING FROM OR RELATING TO YOUR INABILITY TO USE THE GXP2120/2110 TO CONTACT EMERGENCY SERVICES, AND YOUR FAILURE TO MAKE ADDITIONAL ARRANGEMENTS TO ACCESS EMERGENCY SERVICES IN ACCORDANCE WITH THE IMMEDIATELY PRECEDING PARAGRAPH.

## PRECAUTIONS:

**WARNING:** Please DO NOT power cycle the GXP2120/2110 when the LED lights are flashing during system boot up or firmware upgrade. You may corrupt firmware images and cause the unit to malfunction.

**WARNING:** Use only the power adapter included in the GXP2120/2110 package. Using an alternative non-qualified power adapter may possibly damage the unit.

## OVERVIEW

The GXP2120/2110 IP Phones has sleek outer design and delivers excellent call quality and enterprise grade feature set that includes advanced XML capabilities, multi-party conferencing, multi-language support, presence and BLF (busy lamp field), security protection, automated provisioning, and broad compatibility with leading SIP platforms. The GXP2110 offers 4 lines, 18 programmable keys, 3 XML programmable soft keys and the GXP2120 offers 6 lines, 4 XML programmable soft keys, and 7 programmable keys.

## PACKAGE CONTENTS:



1 X Phone Main Case



1 X Handset



1 X 5V Power adapter



1x Ethernet Cable



1 X Phone Cord



1 X High Stand  
1 X Short Stand



2 X Wall Mount  
Spacers



1 X Quick Install Guide

## PHONE SETUP:



### Installing the phone (Wall Mount):

1. Attach the two wall mount spacers to the slot for wall mount spacers on the back of the phone.
2. Attach the phone to the wall via the wall mount hole
3. Pull out the tab on from the handset cradle. (See figure below)
4. Rotate the tab and plug it back into the slot with the extension up to hold the headset while the phone is mounted on the wall. (See figure below)



### Installing the phone (Phone Stand) :

For installing the phone on the table with the phone stand, attach the phone stand to the bottom of the phone where there is a slot for the phone stand. (Upper half, bottom part).

### CONNECTING THE PHONE:

Refer to the illustration below when following the setup instructions .



To setup the GXP2120/2110, follow the steps below:

1. Connect the handset and main phone case with the phone cord.
2. Connect the LAN port of the phone to the RJ-45 socket of a hub/switch or a router (LAN side of the router) using the Ethernet cable.
3. Connect the 5V DC output plug to the power jack on the phone; plug the power adapter into an electrical outlet.
4. The LCD will display provisioning or firmware upgrade information. Before continuing, please wait for the date/time display to show up.
5. Using the phone embedded web server or keypad configuration menu, you can further configure the phone using either a static IP or DHCP.

## Tips For Using the Keypad:



GXP2120 Keypad



GXP2110 Keypad

1. To access the MENU, press the round MENU button.
2. Navigate the menu by using the UP/DOWN and LEFT/RIGHT buttons.
3. Press the round MENU button to confirm a menu selection.
4. Delete an entry by pressing the MUTE button.
5. The phone automatically exits MENU mode with an incoming call, the phone is off-hook or the MENU mode is left idle for 20 seconds.

## PHONE CONFIGURATION:

### Configure the GXP2120/2110 using a Web Browser:

1. Ensure your phone is powered up and connected to the Internet.
2. Press MENU button to go into menu of the phone.

3. Press down arrow button to Status and press MENU button to see IP address.
4. Type the phone's IP address in your PC browser. (See figure below)
5. The default administrator password is "admin"; the default end-user password is "123".



### Configure the GXP2120/2110 using the Keypad:

1. Make sure the phone is idle
2. Press the "MENU" button to access the keypad MENU to configure the phone.
3. Select MENU-> Config, to configure settings for SIP Proxy, Outbound Proxy, SIP User ID, SIP Auth ID, SIP Password
4. Follow MENU options to configure the basic features of the phone – for example: the IP address if using a static IP. For details, please check GXP Series User Manual.
5. Please contact your ITSP for additional settings that may be necessary to configure the phone.

## GXP2120/2110 EXT EXPANSION MODULE

The GXP2120/2110 EXT module is an ideal solution for the busy enterprise environment looking to add the ability to receive and dispatch calls efficiently. Each expansion module has 56 programmable buttons. The GXP phone supports up to two EXT Modules, adding 112 fully programmable phone extensions to the phone.

Note: The extension module is an additional accessory for the GXP2120/2110 and is not included in the box



## PRECAUTIONS:

**ALERTE:** Veuillez ne pas redémarrer le GXP2120/2110 lorsque les voyants clignotent durant le démarrage du système ou la mise à jour du firmware. Ca peut corrompre l'image du firmware et causer un dysfonctionnement de l'unité.

**ALERTE:** N'utilisez que le boîtier d'alimentation fourni dans le pack GXP2120/2110. L'utilisation d'un autre boîtier d'alimentation non qualifié peut endommager l'unité.

## PRESENTATION

Les Téléphones IP GXP2120/2110 ont un design extérieur élégant et offrent une excellente qualité d'appel et un ensemble de caractéristiques de qualité d'entreprise qui inclut des capacités XML avancées, multi conférence, le support de plusieurs langues, la présence et BLF, la sécurité de protection, d'approvisionnement automatisé, et une large compatibilité avec les principales plates-formes SIP. Le GXP2110 offre 4 lignes, 18 touches programmables, 3 touches programmables XML et le GXP2120 dispose de 6 lignes, 4 touches programmables XML, et 7 touches programmables.

## CONTENU DU PACK :



1 X Appareil téléphonique



1 X Combiné



1 X Boîtier d'alimentation 5V



1 X Câble Ethernet



1 X Câble téléphonique



1X Positionneur Elevé  
1X Petit Positionneur



2 X Support Mural  
Entretoises



1 X Guide d'installation  
rapide

## INSTALLATION DU TELEPHONE:



### Installation du téléphone (montage sur le mur):

1. Fixez les deux entretoises dans la fente au dos du téléphone pour le montage mural.
2. Joindre le téléphone au mur par le trou du support mural.
3. Tirez la languette du support du combiné. (Voir figure ci-dessous)
4. Faire pivoter l'onglet et branchez-le dans la fente, avec l'extension jusqu'au tenir le casque d'écoute alors que le téléphone est monté sur le mur. (Voir figure ci-dessous)



## Installation du téléphone (Positionneur téléphonique):

“Pour installer le téléphone sur la table avec le positionneur du téléphone, joignez ce dernier à la base du téléphone où il y a une fente. (Moitié supérieure, une partie du bas).

## CONNECTER LE TELEPHONE:

Reportez-vous à l'illustration ci-dessous en suivant les instructions d'installation.



Pour installer le GXP2120/2110, suivez les instructions ci-dessous :

1. Connectez le combiné et le boîtier de téléphone principal avec le câble téléphonique.
2. Connecter le port LAN de votre téléphone au port RJ-45 d'un concentrateur / commutateur ou un routeur (côté LAN du routeur) à l'aide du câble Ethernet.
3. Connectez la fiche de sortie 5V DC à la prise d'alimentation sur le téléphone, branchez l'adaptateur dans une prise électrique.
4. Le LCD va afficher les informations de provisionnement ou de mise à jour du firmware. Avant de continuer, veuillez patienter jusqu'à que la date/heure s'affiche.
5. En utilisant le serveur web intégré du téléphone ou le menu de la configuration du téléphone, vous pouvez le configurer en utilisant soit IP statique ou DHCP.

## Conseils d'utilisation du clavier :



GXP2120



GXP2110

1. Pour accéder au MENU, appuyez sur le bouton circulaire MENU.
2. Naviguez dans le menu en utilisant les boutons HAUT/BAS et GAUCHE/DROITE.
3. Appuyez sur le bouton circulaire MENU pour confirmer la sélection.
4. Supprimer une entrée en appuyant sur le bouton MUET.
5. Le téléphone quitte automatiquement le mode MENU quand il y a un appel entrant, le téléphone est décroché, ou lorsque le mode MENU est laissé inactif pendant 20 secondes.

## CONFIGURATION DU TELEPHONE :

### Configurer le GXP2120/2110 en utilisant le Navigateur web :

1. Vérifiez que votre téléphone est sous tension et connecté à Internet.
2. Appuyez sur le bouton MENU pour aller dans le menu du téléphone.





El GXP2120/2110 no está pre-configurado para soportar o realizar llamadas de emergencia a ningún tipo de hospital, agencia policial, unidad de cuidado médico o cualquier otro servicio de emergencia. Es su responsabilidad contratar un servicio de telefonía de Internet compatible con el protocolo SIP, configurar el GXP2120/2110 para utilizar dicho servicio y periódicamente probar esta configuración para confirmar que está trabajando como usted espera. Si este requisito no es completado, es su responsabilidad contratar un servicio de telefonía fija o celular para tener acceso a servicios de emergencia.

GRANDSTREAM NO PROVEE CONEXIONES A SERVICIOS DE EMERGENCIA A TRAVÉS DEL GXP2120/2110. NI GRANDSTREAM NI NINGUNO DE SUS OFICIALES, EMPLEADOS O AFILIADOS SON RESPONSABLES DE NINGUNA DEMANDA, DAÑO O PERDIDA QUE ESTO PUEDA OCASIONAR Y MEDIANTE ESTE COMUNICADO USTED RENUNCIA A CUALQUIER RECLAMO O CONSECUENCIA PROVENIENTE O RELACIONADO DE LA INHABILIDAD DE CONTACTAR SERVICIOS DE EMERGENCIAS CON EL GXP2120/2110 Y SU FALTA DE NO HABER HECHO LOS ARREGLOS DE LUGAR PARA ACCESAR ESTOS SERVICIOS DE EMERGENCIA DE ACUERDO CON EL PÁRRAFO ANTERIOR.

## PRECAUCIONES:

**ADVERTENCIA:** No apague el GXP2120/2110 cuando las luces indicadoras se encuentren en estado intermitente al momento de iniciar el equipo o actualizar el firmware. Esto podría ocasionar que la unidad no continúe funcionando correctamente.

**ADVERTENCIA:** Solamente utilice la fuente de poder incluida en el paquete del GXP2120/2110. Utilizar un adaptador de poder alternativo no certificado podría dañar su unidad.

## INFORMACIÓN GENERAL

El teléfono IP GXP2120/2110 tiene un diseño elegante y entrega una excelente calidad de llamadas y características avanzadas como XML, conferencia multi-usuarios, soporte para varios lenguajes, teclas de presencia y BLF (busy lamp field), protección de seguridad, aprovisionamiento automático y excelente compatibilidad con la gran mayoría de las plataformas SIP. El GXP2110 tiene 4 líneas, 18 teclas programables, 3 teclas suaves programables mientras que el GXP2120 presenta 6 líneas, 4 teclas suaves programables y 7 teclas programables.

## LO QUE CONTIENE EL PAQUETE:



1 X Unidad Principal



1 X Auricular



1 X Fuente de poder de 5V



1 X Cable de Red Ethernet



1 X Cable Telefónico



1 X Un soporte alto  
1 X Un soporte bajo



2 X Espaciadores de Pared

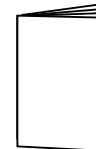

1 X Guía de Instalación Rápida

## INSTALACIÓN DEL TELÉFONO:



### Instalando el teléfono (Montura de Pared):

1. Inserte los dos espaciadores para montura en la pared en los orificios de la parte de abajo del teléfono.
2. Coloque el teléfono en la pared utilizando los orificios.
3. Halé la lengüeta de la horquilla del auricular.
4. Coloque la lengüeta en la misma ranura de tal manera que soporte el auricular una vez el teléfono este colgado de la pared.

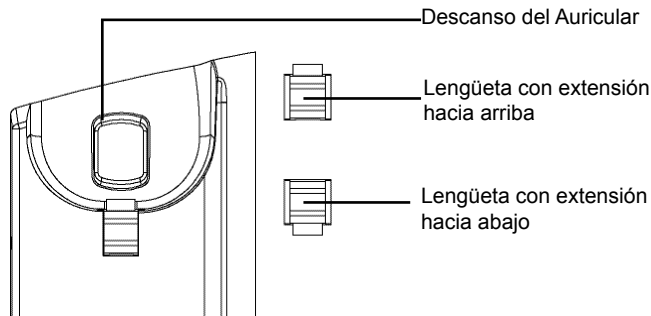

## Instalando el teléfono (Sobre escritorio)

Para instalar el teléfono sobre un escritorio, utilice el soporte del teléfono y colóquelo en la parte inferior del teléfono donde se encuentra la ranura para el soporte.

## CONECTANDO EL TELÉFONO:

Haga referencia a la figura de mas abajo al seguir las instrucciones.

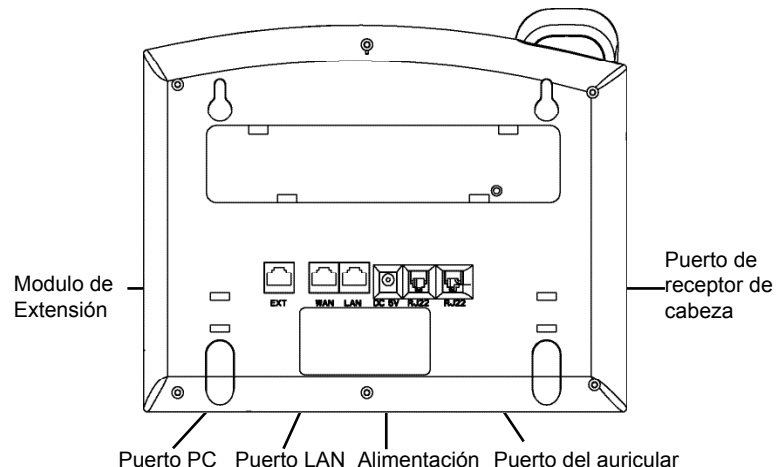

Para configurar el GXP2120/2110, siga los pasos detallados abajo:

1. Conecte el auricular a la unidad utilizando el cable telefónico.
2. Conecte el puerto LAN del teléfono al zócalo RJ-45 de un hub/switch o router usando el cable Ethernet.
3. Conecte la fuente de poder de 5V DC a la salida de alimentación del teléfono y la salida de electricidad.
4. La pantalla LCD va a mostrar un mensaje de aprovisionamiento o actualización de firmware. Antes de continuar espero hasta que la pantalla muestra el tiempo y la fecha.
5. Utilizando la interfase Web integrada accediendo la dirección IP del teléfono en un navegador Web o mediante el teclado, configure el teléfono utilizando una dirección IP estática o dinámica con DHCP.

## Sugerencias para Usar el Teclado:



GXP2120



GXP2110

1. Para acceder al MENU, presione la tecla circular MENU.
2. Para navegar el menú utilice las teclas direccionales.
3. Presione el botón de MENU para confirmar su selección.
4. Borre una entrada presionando la tecla de MUTE.
5. El teléfono va a salir del MENU cuando hay una llamada entrante, el auricular es levantado o cuando el teléfono permanece en reposo por 20 segundos.

## CONFIGURACIÓN DEL TELÉFONO:

### Configurando el GXP2120/2110 utilizando un navegador Web:

1. Asegure que su teléfono este conectado a la red y tenga electricidad.
2. Presione el botón de MENU.

3. Navegue hasta la opción de "Status" y presione MENU para descubrir la dirección IP del teléfono.
4. Ingrese la dirección IP del teléfono en su navegador.
5. La clave de administrador por defecto es "admin"; para usuarios finales es "123".



### Configurando el GXP2120/2110 usando el teclado:

1. Asegure que el teléfono se encuentre en reposo.
2. Presione la botón de MENU.
3. Seleccione Config, para configurar el SIP Proxy, Outbound Proxy, SIP User ID, SIP Auth ID, SIP Password.
4. Continúe navegando por las opciones de MENU para configurar otras opciones básicas.
5. Contacte a su proveedor de servicio de telefonía para cualquier modificación adicional que sea necesaria.

## MODULO DE EXTENSIÓN GXP2120/2110 EXT

El modulo de extensión GXP2120/GXP2110 EXT es una solución ideal para empresas de alto trafico que quieren mejorar la eficiencia de la recepción y el despacho de llamadas. Cada modulo de expansión tiene 56 teclas programables. El teléfono GXP soporta hasta dos módulos EXT, añadiendo hasta 112 teclas programables al teléfono.

Nota: El modulo de extensión es un accesorio adicional para el GXP2120/2110 y no es incluido en el paquete.



## VORSICHTSMAßNAHMEN:

**WARNUNG:** Schalten Sie bitte das GXP2120/2110 NICHT aus und wieder ein, wenn die LED-Lichter während der Systemaufladung oder der Firmware-Aktualisierung blinken. Die Firmware-Bilder können dadurch fehlerhaft werden, sowie die Störfunktionen des Geräts werden dadurch ermittelt.

**WARNUNG** Verwenden Sie nur den im GXP2120/2110 Paket eingeschlossenen Netzadapter. Die Verwendung eines alternativen, nicht geeigneten Netzadapters kann vielleicht das Gerät beschädigen.

## ÜBERSICHT:

Die IP-Telefone GXP2120/2110 haben glatten äußeren Entwurf und liefern die ausgezeichnete Anrufqualität und die Funktionseigenschaften für den Rang jedes Unternehmens, die Folgendes beinhalten: die fortgeschrittenen XML-Ressourcen, die Multiparteien-Konferenzschaltung, mehrsprachige Unterstützung, Anwesenheit und BLF (beschäftigtes Lampenfeld), Sicherheitsschutz, automatisierte Bereitstellung und ausgedehnte Kompatibilität mit führenden SIP-Plattformen. Das GXP2110 bietet 4 Leitungen, 18 programmierbare Schlüssel, 3 XML programmierbare Softkeys an, und das GXP2120 bietet 6 Leitungen, 4 XML programmierbare Softkeys und 7 programmierbare Schlüssel an.

## PAKETINHALT:



1 X Telefonhauptgehäuse



1 X Hörer



1 X 5V Netzadapter



1x Ethernet-Kabel



1 X Telefonschnur



1 X Großer Standplatz  
1 X Kleiner Standplatz



2 X Wanddistanzhalter



1x Schnellstartanleitung

## TELEFON-SETUP:

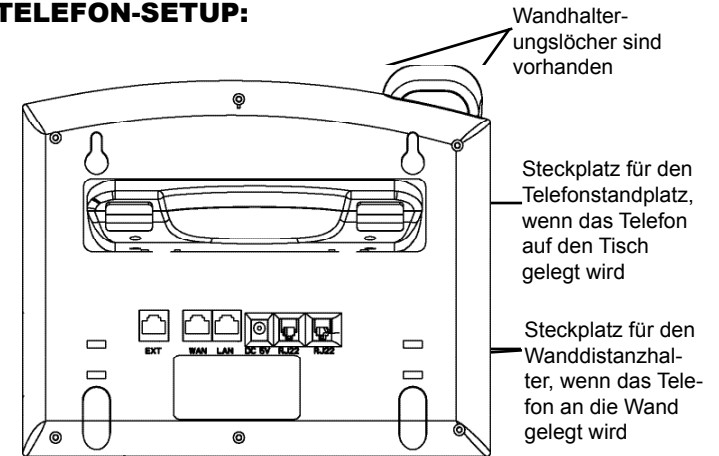

## Telefoninstallation (Wandhalterung):

1. Bringen Sie 2 Wanddistanzhalter in den Steckplatz für die Wanddistanzhalter an der Unterseite des Telefons an.
2. Bringen Sie das Telefon an der Wand über das Wandhalterungsloch an.
3. Ziehen Sie den Tab von der Telefongabel aus. (Sehen Sie die Abbildung unten)
4. Drehen Sie den Tab und stecken Sie ihn zurück in den Steckplatz mit der Erweiterung hinauf, um den Kopfhörer zu halten, während das Telefon an der Wand angebracht wird. (Sehen Sie die Abbildung unten)

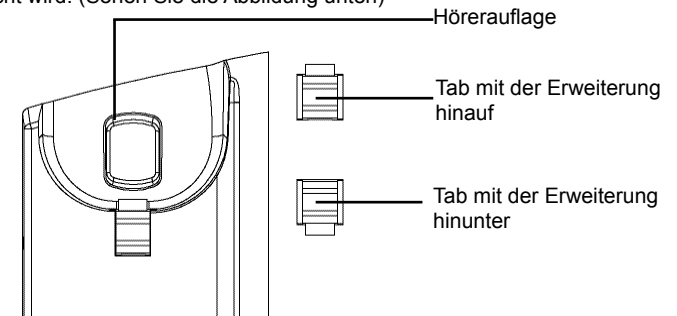

## Telefoninstallation (Telefonstandplatz):

Für die Installation des Telefons auf den Tisch mit dem Telefonstandplatz, bringen Sie den Telefonstandplatz an der Unterseite des Telefons an, in dem es einen Steckplatz für den Telefonstandplatz gibt. (Die obere Hälfte, der Unterteil).

## ANSCHLIEßEN DES TELEFONS:

Beziehen Sie sich auf die Abbildung unten, wenn Sie den Instruktionen für die Installation folgen.



Für das GXP2120/2110-Setup folgen Sie den Schritten unten:

1. Schließen Sie den Hörer und das Haupttelefongehäuse an die Telefonschnur an.
2. Schließen Sie den LAN-Anschluss des Telefons an die RJ-45 Steckdose eines Netzknotts/Schalters oder eines Routers (LAN-Seite des Routers), unter Verwendung des Ethernet-Kabels an.
3. Schließen Sie den 5V DC-Ausgangsstecker an die Energiensteckfassung am Telefon an; stecken Sie den Netzadapter in einen elektrischen Anschluss ein.
4. Die LCD wird die Bereitstellung oder Firmware-Aktualisierung der Information anzeigen. Bevor Sie fortfahren, warten Sie bitte, dass die Datum-/Zeitanzeige erscheint.

## Tipps für die Tastaturanwendung:



1. Um auf das MENÜ zuzugreifen, drücken Sie den runden MENÜKNOPF.
2. Steuern Sie das Menü, indem Sie die Knöpfe UP/DOWN und LEFT/RIGHT verwenden.
3. Drücken Sie den runden MENÜKNOPF, um eine Menüauswahl zu bestätigen.
4. Löschen Sie einen Eintrag, indem Sie den Knopf STUMM drücken.
5. Das Telefon verlässt automatisch den Maskenmodus, wenn es einen eingehenden Anruf gibt, wenn das Telefon abgehoben wird, oder wenn der Maskenmodus untätig 20 Sekunden gelassen wird.

## TELEFONKONFIGURATION:

**Konfigurieren Sie das GXP2120/2110, unter Verwendung von Web Browser:**

1. Stellen Sie sicher, dass Ihr Telefon angeschaltet und mit dem Internet verbunden wird.
2. Drücken Sie den MENÜKNOPF, um in Menü des Telefones einzutreten.



GXP2120/2110 non è preconfigurato per supportare o effettuare chiamate di emergenza a qualsiasi tipo di ospedale, struttura giudiziaria, unità di assistenza medica (“Servizi di emergenza”) o a qualsiasi altro tipo di servizio di emergenza. È necessario effettuare accordi supplementari per accedere ai Servizi di emergenza. È a Vostra esclusiva responsabilità acquistare servizi di telefonia internet conformi con SIP, configurare GXP2120/2110 correttamente per usare tale servizio ed effettuare test periodici della configurazione per assicurarsi che funzioni in modo idoneo. Se non si effettua ciò, è Vostra responsabilità acquistare servizi telefonici fissi o wireless tradizionali per accedere ai Servizi di emergenza.

GRANDSTREAM NON FORNISCE COLLEGAMENTI AI SERVIZI DI EMERGENZA ATTRAVERSO GXP2120/2110. NÈ GRANSTREAM NÈ I SUOI RESPONSABILI, DIPENDENTI O AFFILIATI POSSONO ESSERE RITENUTI RESPONSABILI DI QUALSIASI RECLAMO, DANNO O PERDITA, E DI QUALSIASI AZIONE LEGALE DERIVI DA TALI RECLAMI O CAUSE IN RELAZIONE ALL'IMPOSSIBILITÀ DI USARE IL GXP2120/2110 PER CHIAMATE AI SERVIZI DI EMERGENZA E ALL'IMPOSSIBILITÀ DI EFFETTUARE ACCORDI SUPPLEMENTARI PER ACCEDERE AI SERVIZI DI EMERGENZA IN CONFORMITÀ AL PARAGRAFO PRECEDENTE.

## PRECAUZIONI:

**AVVERTENZA:** NON spegnere/accendere il GXP2120/2110 mentre i LED lampeggiano durante l'avvio del sistema o l'aggiornamento del firmware. Ciò potrebbe comportare il danneggiamento del firmware e il malfunzionamento dell'unità.

**AVVERTENZA:** Usare solo l'alimentatore incluso nella confezione del GXP2120/2110. L'uso di un alimentatore alternativo non idoneo potrebbe danneggiare l'unità.

## PANORAMICA:

I telefoni IP GXP2120/2110 hanno un design elegante e forniscono un'eccellente qualità di chiamata e soddisfano tutte le possibili esigenze di un'impresa che includono capacità XML avanzate, conferenza multiutente, supporto multilingue, presenza e BLF (campo spia occupato), protezione di sicurezza e ampia compatibilità con le principali piattaforme SIP. Il GXP2110 offre 4 linee, 18 tasti programmabili, 3 tasti funzione XML programmabili, mentre il GXP2120 offre 6 linee, 4 tasti funzione XML programmabili e 7 tasti programmabili.

## PACKAGE CONTENTS:



1 X case principale telefono



1 X ricevitore

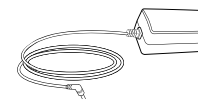

1 X alimentatore 5V

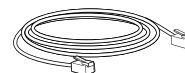

1 X cavo ethernet



1 X cavo telefonico



1 X supporto alto  
1 X supporto corto



2 X distanziali per montaggio a parete

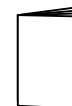

1 X guida introduttiva rapida



## MONTAGGIO TELEFONO:



### Installazione del telefono (montaggio a parete):

1. Fissare i due distanziali per il supporto a parete nell'apposito alloggiamento sul retro del telefono..
2. Fissare il telefono alla parete attraverso il foro di montaggio a parete.
3. Estrarre l'aletta dal ricevitore. (Si veda la figura di seguito)
4. Ruotare l'aletta e riposizionarla nell'alloggiamento con l'estensione verso l'alto in modo da poter sostenere il telefono mentre è montato a parete. (Si veda la figura di seguito)



### Installazione del telefono (supporto telefono):

Per installare il telefono sul tavolo con il supporto telefono, fissare il supporto alla base del telefono dove si trova un alloggiamento per tale supporto. (metà superiore, parte inferiore).

### CONNESSIONE DEL TELEFONO:

Fare riferimento all'illustrazione riportata di seguito quando si seguono le istruzioni di installazioni



Per impostare il GXP2120/2110, seguire la seguente procedura:

1. Collegare il ricevitore e il case principale del telefono con il cavo telefonico.
2. Collegare la porta LAN del telefono alla presa RJ-45 di un hub o di un router (lato LAN del router) usando un cavo ethernet.
3. Collegare il jack dell'alimentatore all'uscita 5V CC sul telefono; collegare l'alimentatore a una presa elettrica.
4. L'LCD visualizzerà le informazioni relative allo stato dell'apparecchio o all'aggiornamento del firmware. Prima di continuare, attendere che il display visualizzi data/ora.
5. Usando il server web del telefono o il menu di configurazione del tastierino numerico, è possibile inoltre configurare il telefono usando o un IP statico o un DHCP.

## Consigli per l'uso del tastierino:



GXP2120



GXP2110

1. Per accedere al MENU, premere il pulsante circolare MENU.
2. Muoversi nel menu usando i pulsanti UP/DOWN e LEFT/RIGHT.
3. Premere il pulsante circolare MENU, per confermare una scelta effettuata nel menu.
4. Cancellare un'immissione premendo il pulsante MUTE.
5. Il telefono esce automaticamente dalla modalità MENU quando arriva una chiamata, quando il telefono è sganciato o quando la modalità MENU non è usata per 20 sec.

## CONFIGURAZIONE DEL TELEFONO:

### Configurazione del GXP2120/2110 mediante un browser web:

1. Assicurarsi che il telefono sia in corrente e collegato a internet.
2. Premere il pulsante MENU per accedere al menu del telefono.

3. Premere la freccia "giù" per portarsi su "Stato" e premere il pulsante MENU per visualizzare l'indirizzo IP.
4. Digitare l'indirizzo IP del telefono nel browser del vostro PC.
5. La password amministratore predefinita è "admin"; la password predefinita per l'utente finale è "123".



### Configurazione del GXP2120/2110 mediante il tastierino:

1. Assicurarsi che il telefono sia in stato di attesa (modalità idle).
2. Premere il pulsante "MENU" per accedere al tastierino MENU per configurare il telefono.
3. Selezionare MENU-> Config, per configurare le impostazioni SIP Proxy, Proxy in uscita, SIP User ID, SIP Aut ID, SIP Password.
4. Seguire le opzioni del MENU per configurare le impostazioni di base del telefono - ad esempio: l'indirizzo IP se si usa un IP statico. Per ulteriori informazioni, consultare il manuale utente della serie GXP.
5. Contattare il vostro ITSP (fornitore servizi di telefonia internet) per le impostazioni supplementari che possono essere necessarie per la configurazione del telefono.

## MODULO DI ESPANSIONE GXP2120/2110 EXT

"Il modulo GXP2120/2110 EXT è una soluzione ideale per l'impresa che mira ad ottenere una perfetta possibilità di ricevere ed effettuare chiamate. Ogni modulo di espansione ha 56 pulsanti programmabili. Il telefono GXP supporta fino a due moduli EXT, aggiungendo 112 estensioni completamente programmabili al telefono.

Nota: Il modulo di estensione è un accessorio aggiuntivo per il GXP2120/2110 e non è incluso nella confezione



## ÖNLEMLER:

**UYARI:** Lütfen sistem başlatıldığı ya da donanım yazılımı güncellendiği sırada LED ışıkları yanıp sönerken GXP2120/2110 birimini yeniden BAŞLATMAYINIZ. Donanım yazılımı kopyalarını bozabilir ve birimin arızalanmasına sebep olabilirsiniz.

**UYARI:** Sadece GXP2120/2110 ambalajından çıkan güç adaptörünü kullanınız. Alternatif niteliksiz güç adaptörlerinin kullanımı birimde olası hasara sebep olabilir.

## GENEL BAKIŞ:

GXP2120/2110 IP Telefonları zarif dış tasarıma sahiptir ve mükemmel çağrı kalitesi ile gelişmiş XML yeteneği, çoklu taraf konferans, çoklu dil desteği, hazır olma ve BLF (meşgul ışık alanı), güvenlik koruma, otomatik yapılandırma, öncü SIP platformları ile geniş uyumluluk içeren işletme sınıfı özellikler seti sağlar. GXP2110, 4 adet hat, 18 adet programlanabilir tuşlar, 3 adet XML programlanabilir yumuşak tuş sunar ve GXP2120, 6 adet hat, 4 adet XML programlanabilir yumuşak tuş ve 7 adet programlanabilir tuş sunar.

## AMBALAJ İÇERİKLERİ:



1 X Telefon Ana Kasası



1 X Ahize



1 X 5V Güç Adaptörü



1x Ethernet Kablosu



1 X Telefon Kordonu



1X Yüksek Stant  
1 X Kısa Stant



2 X Duvar Monte Ara Parçaları



1 X Hızlı Kurulum Kılavuzu

## TELEFON KURULUMU:



## Telefonun Kurulumu (Duvara Monte):

1. Duvar monte ara parçaları olarak telefon standını telefonun altına takın.
2. Telefonu, duvar monte deliğinden duvara takın.
3. Çıkıntılı parçayı ahize yuvasından çekip çıkarın. (Aşağıdaki şekle bakınız)
4. Telefon duvara monteliyken ahizeyi tutması için çıkıntılı parçayı döndürün ve çıkıntı parça ucu yukarı gelecek şekilde yuvasına tekrar takın. (Aşağıdaki şekle bakınız)



## Telefon Kurulumu (Telefon Standı):

Telefonu masaya telefon standı ile kurmak için, telefonun altında bulunan telefon standı için boşluk olan yere telefon standını takın. (Üst yarım, alt parça).

## TELEFONUN BAĞLANMASI:

Kurulum talimatlarını takip ederken aşağıdaki resme bakınız.



GXP2120/2110 birimini kurmak için aşağıdaki adımları izleyiniz:

1. Ahizeyi, ana telefon kasasına telefon kablosu ile bağlayınız.
2. Telefonun LAN portunu, Ethernet kablosunu kullanarak hub/anahtara veya bir yönlendiriciye (yönlendiricinin LAN tarafına) ait RJ-45 soketine bağlayınız.
3. 5V DC çıkışı bağlantısını, telefon üzerindeki güç jakına bağlayınız; güç adaptörünü elektrik prizine takınız.
4. LCD, konfigürasyon ya da donanım yazılımı güncelleme bilgisini gösterecektir. Devam etmeden önce, lütfen tarih/zaman ekranının görünmesini bekleyiniz.
5. Telefonun gömülü olduğu web sunucusunu ya da tuş takımı yapılandırma menüsünü kullanarak, statik IP ya da DHCP kullanarak telefonun ileri yapılandırmasını yapabilirsiniz.

## Tuş Takımını Kullanımı için İpuçları:



GXP2120

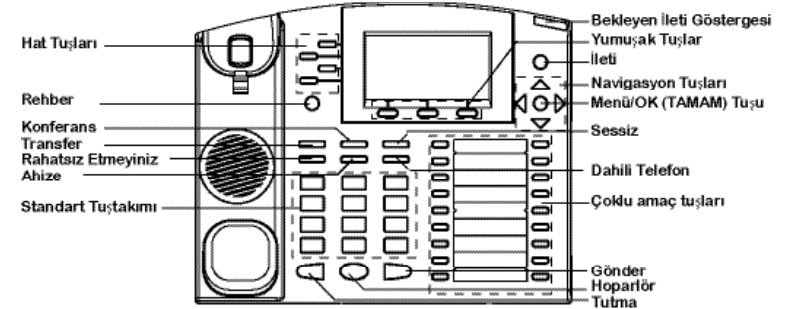

GXP2110

1. MENÜ'ye erişmek için yuvarlak MENÜ düğmesine basınız.
2. YUKARI/AŞAĞI ve SOL/SAĞ düğmelerini kullanarak menüde gezin.
3. Bir menü seçimini yapılandırmak için yuvarlak MENÜ düğmesine basınız.
4. SESSİZ düğmesine basarak girdileri siliniz.
5. Gelen bir çağrı olduğunda, ahize kaldırıldığında ya da MENÜ modu 20 saniye boyunca işlem yapılmadığında, telefon otomatik olarak MENÜ modundan çıkar.

## TELEFON YAPILANDIRMASI:

### Web Tarayıcı kullanarak GXP2120/2110 yapılandırılması:

1. Telefonunuzun gücünün açık olduğundan ve İnternete bağlı olduğundan emin olun.
2. Telefonun menüsüne girmek için MENÜ düğmesine basın.

