

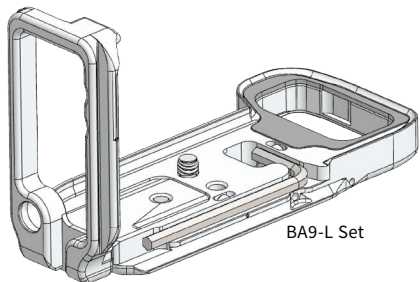

1146 Farmhouse Lane, San Luis Obispo, CA 93401 USA
 1-805-528-6321 | 1-888-777-5557
 www.ReallyRightStuff.com

PLATE FOR SONY a7R III & a9



BA9-L Set

- BA9
- BA9-L SET

SPECIFICATIONS

BA9 Base Plate.....	3.3oz / 94g
BA9-L Set.....	5.0oz / 142g

MODULAR COMPONENTS

BA9

Contoured wrap-around design mates perfectly with camera base. Provides full access to battery/card compartment.

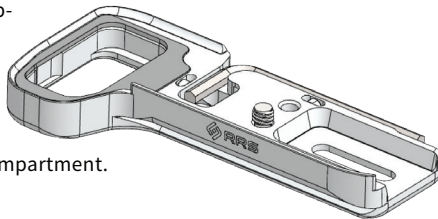

BA9-L Set

Includes Base + L-Component. The L-component can be shifted away from camera to provide additional port access by loosening the bottom screw in the horizontal slot. Integrated hex key storage keeps tool handy.

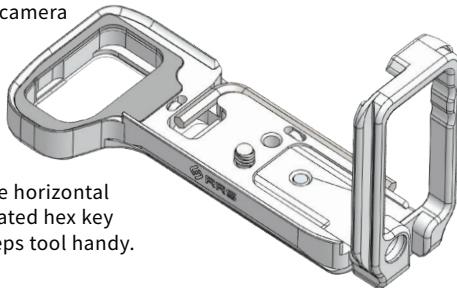

FEATURES

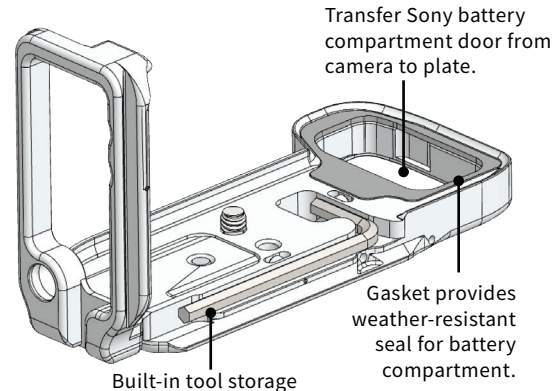

GUARANTEE

ALL REALLY RIGHT STUFF BRAND PRODUCTS ARE GUARANTEED TO THE ORIGINAL PURCHASER TO BE FREE OF DEFECTS IN MATERIALS OR WORKMANSHIP FOR FIVE (5) YEARS FROM THE DATE OF PURCHASE. PRODUCTS WILL BE REPAIRED OR REPLACED AT OUR OPTION.

®, ™, © 1990-2018 Really Right Stuff, Inc. All rights reserved.

INSTALLATION

1) Open Battery Door on bottom of camera.

2) On the inside of the Door, pull the release button in the direction of the arrow. This will retract the pins to allow easy removal of the Battery Door. Set the Door aside.

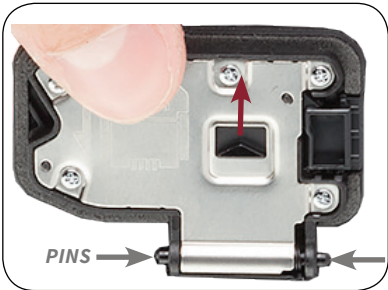

3) Install RRS plate on camera. (If you wish to also install a strap, it is easier to do so before installing the plate.)



4) Retrieve Door. Pull the release button in the direction of the arrow to retract the pins on the Door.

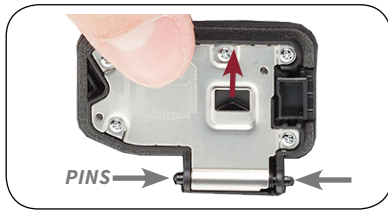

5) Align the pins of the Battery Door with the two pinholes on the plate, angle into position, and release the button. This will allow the pins to pop out and lock the Door in place.



6) Open and close the Battery Door several times to ensure proper fit and function.

Note: When inserting the battery with the plate installed, use a similar angle of entry as you would without the plate.



ADDITIONAL FEATURES

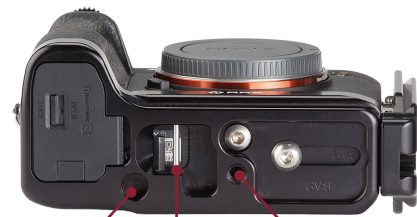

QD socket

Strap attachment

1/4"-20 threaded
accessory mounting
socket

