







ASSEMBLY INSTRUCTION

Model: U5987-PCRLS



Description: POWER CONSOLE RECLINING LOVESEAT

Thank you for purchasing this quality product. Be sure to check all packing material carefully for small parts that may have come loose inside the carton during shipment

PARTS LIST:

NO.	DESCRIPTION	SKETCH	Q'TY
A	Seat Body		1 PC
B	Left Backrest		1 PC
C	Console Backrest		1 PC
D	Right Backrest		1 PC
E	Left wing		1 PC
F	Right wing		1 PC

HARDWARE LIST:

NO.	DESCRIPTION	DESCRIPTION	SKETCH	QTY
1	Plug			1 PC
2	Transformer			1 PC

Step 1:

Important:

1. Attach the Backrest (B/C/D) to the Seat (A).
2. Attach the Left/Right Wings (E/F) to the Left/Right side of the Backrest (B/D).

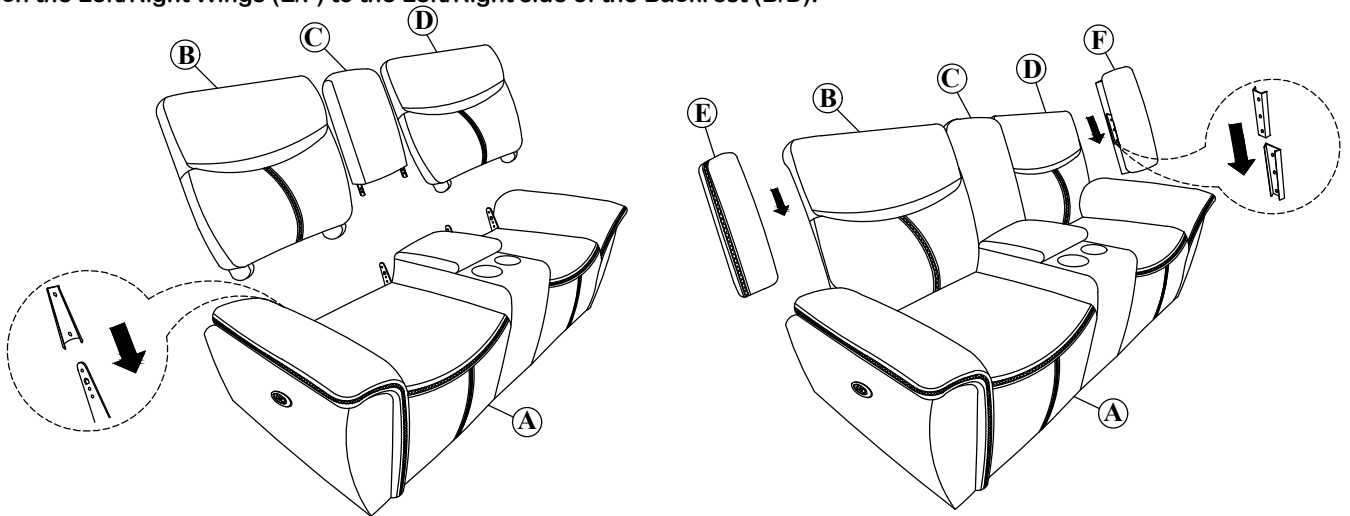

Step 2:

Important:

1. Connect the power wire under the Armrest frame to the power source through out the Transformer (2) and The Plug (1).
2. Open the footrest or move the headrest by pressing the power button on/off.

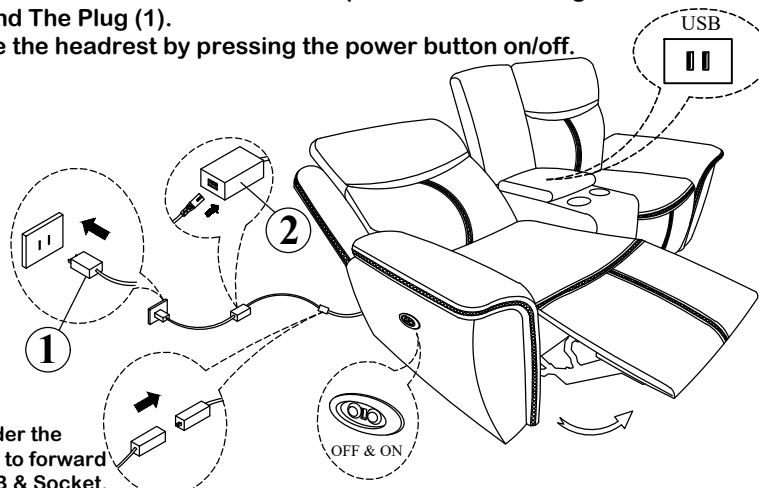

Notes: Connect the power source under the metal frame, fold the middle backrest to forward then press the button to open the USB & Socket.

Made in Vietnam