

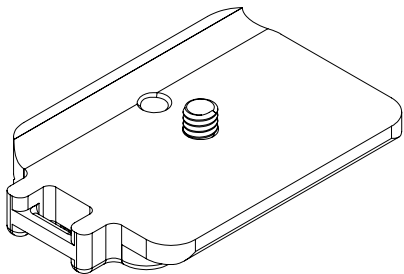

1146 Farmhouse Lane, San Luis Obispo, CA 93401 USA
 1-805-528-6321 | 1-888-777-5557
 www.ReallyRightStuff.com

CAMERA BODY PLATES

PLATE ID



Really Right Stuff body plates are compatible with all Really Right Stuff clamps and any Arca-Swiss style quick-release clamp. Check our website for detailed specifications on all body plates.

TOP VIEW:

strap boss for optional handstrap
(not on all models)

mounting hole with mounting screw

anti-twist flange hugs camera body contours

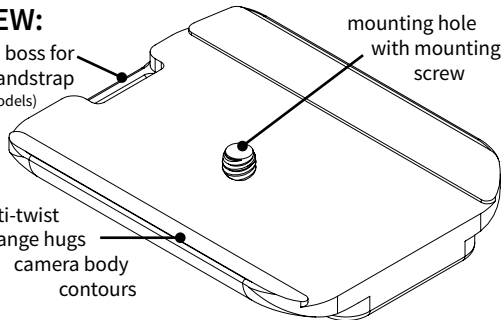

BOTTOM VIEW:

mounting screw with hex socket
(use included hex key)

plate ID

QD socket for optional QD strap
(not on all models; see caution note)

dovetail mates with clamp

strap boss

safety stop screw
(not on all models)

centering index mark
(not on all models)

accessory socket threaded 1/4"-20

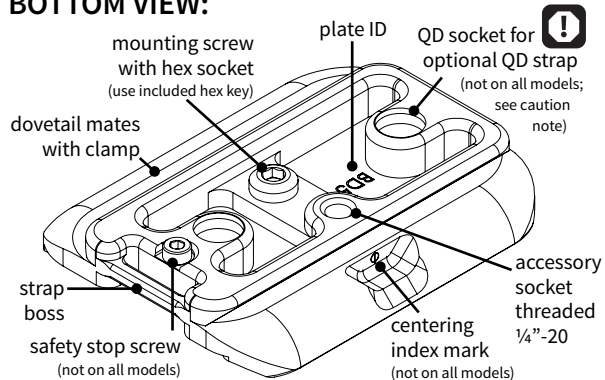

INSTALL PLATE TO CAMERA

Wipe off bottom of camera to prevent trapping dirt or grit. Line up the plate with the safety stop screw on the same side as the grip. Use included hex key to firmly tighten mounting screw.

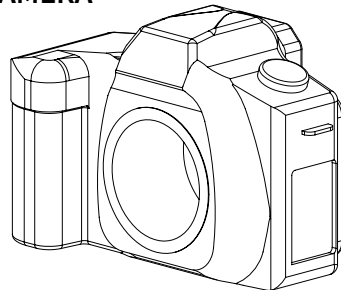

All screws & tools are included.

Orient strap boss (if provided) on this side.

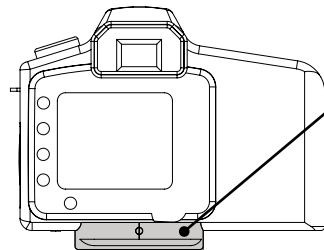
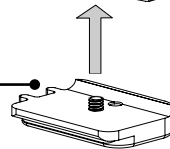

The centering index mark (not on all models) is always laser engraved on the back of the plate. Use this mark to center your camera in the clamp when shooting panoramas.

A NOTE ABOUT DOVETAILS

← Most camera body plates have a single set of dovetail grooves that allow the camera to slide left/right when mounted in the quick-release clamp so that the camera can be centered.

↓ Some medium & large format plates have a fore/aft dovetail so that the camera's weight can be better distributed.

↕ But some plates, known as bidirectional plates, have two sets of dovetail grooves. These allow the camera to slide left/right or fore/aft. Bidirectional plates, due to their design, do not have safety stop screws.

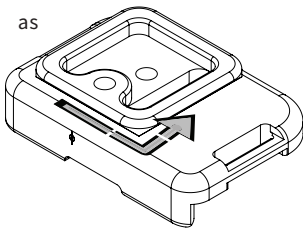

GUARANTEE

ALL REALLY RIGHT STUFF BRAND PRODUCTS ARE GUARANTEED TO THE ORIGINAL PURCHASER TO BE FREE OF DEFECTS IN MATERIALS OR WORKMANSHIP FOR FIVE (5) YEARS FROM THE DATE OF PURCHASE. PRODUCTS WILL BE REPAIRED OR REPLACED AT OUR OPTION.

®, ™, © 2017 Really Right Stuff, LLC. All rights reserved.

MOUNTING PLATE IN CLAMP

Lever Release Clamp

If you have a Really Right Stuff lever-release clamp, **swing the lever fully open and top load the plate.**

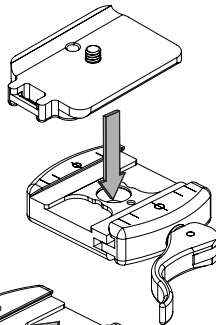

Screw Knob Clamp

If you have a screw-knob clamp, you may top load or side load the plate. Side loading is faster; just turn the knob ½ a turn and the clamp is loose enough to release or load the plate.

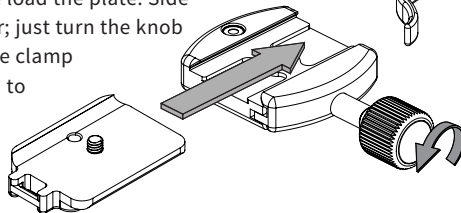

⚠ USING THE QD SOCKET ⚠

Our QD socket accepts industry standard push-button QD mounts. The QD socket must be kept free of dirt or grit to allow the QD mount to fully seat and snap into the socket. **Always check that the QD mount on your strap/swivel is fully seated and completely engaged before use.**

KNOW YOUR GEAR

- The “clamp” is the quick-release part with jaws that is semi-permanently installed on your tripod head. We sell two different styles of clamps: lever-release and screw-knob.
- The “plate” mounts to the bottom of anything (camera, lens, flash) that you want to sit in the clamp. Most RRS plates are customized plates, not generic.
- The “dovetail” is the 45° grooved edge portion of the plate that mates with the clamp. This tongue-&-groove concept was initially applied by the Arca-Swiss company. Equipment that meets this standard is commonly known as Arca-style or Arca-Swiss compatible. All RRS plates are Arca-style plates.
- A “captive screw” stays in the mounting hole or slot, even when the plate is removed from the camera. A captive screw has no threads under the screw head.
- If your clamp is not fully closed, the “safety stop screw” will hit the clamp and stop the plate from sliding through the clamp when you turn the head on its side to shoot in portrait mode.

