



1146 Farmhouse Lane, San Luis Obispo, CA 93401 USA
 1-805-528-6321 | 1-888-777-5557
 www.ReallyRightStuff.com

SNAP QR® SYSTEM ADAPTERS and ACCESSORIES

PRODUCT ID: _____

Our patented *SNAP QR* system is ideal for fast mounting and positioning of photo & video accessories, including strobes, microphones, monitors, and other accessories. The system has two elements that snap together:

- a *SNAP QR* adapter that mounts to the bottom of your strobe or accessory. Choose the adapter that fits your gear.
- a *SNAP QR* mount that accepts the QR adapter. *SNAP QR* mounts are integrated in Really Right Stuff flash brackets, flash mounts, flash accessories, and the FA-QRM.

SNAP QR® is a US registered trademark. SNAP QR products are protected by US Patent No 8,398,315. Prices are subject to change.

HOW IT WORKS

Patented *SNAP QR* System

Choose the QR adapter for your gear. We make adapters for strobes, strobe cords, microphones, LCD monitors, and more.

Install the QR adapter, then snap it into the QR mount. To remove, press down on the QR Latch and remove your gear. Our *SNAP QR* mount is built into all Really Right Stuff flash brackets, flash mounts, flash accessories, and versatile FA-QRM.

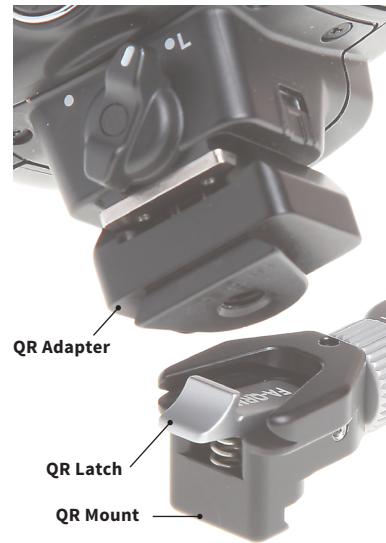

STROBE CORD ADAPTER

FA-QR1 fits most strobe cords

Each Really Right Stuff Flash Bracket and Flash Mount comes with one FA-QR1 adapter. This adapter fits most strobe cords. Add additional FA-QR1 adapters if you have multiple strobe cords, cold shoe mounts, or non-QR flash adapters.



GENERAL PURPOSE ADAPTER

FA-QR2 fits most non-flash accessories

For camera accessories with simple ¼"-20 sockets on flat surfaces such as monitors, microphones, LED lights, etc, choose our FA-QR2 general purpose *SNAP QR* adapter. This small flat adapter incorporates a thin gasket for added friction and a non-twisting mount.

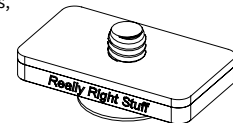

FA-QR1 for off-camera strobe cords.....	\$15
FA-QR2 general purpose adapter.....	\$22

NIKON SC-29 STROBE CORD ADAPTER

FA-QR29

The Nikon SC-29 strobe cord with built-in AF-Assist is larger than standard Nikon cords and requires our FA-QR29 adapter.

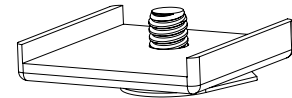

NIKON SB-R200 ADAPTER

FA-QR200 or FA-QR200 Pair

Use FA-QR200 adapter to mount your Nikon SB-R200 Speedlight Head onto any *SNAP QR* mount (instead of using the Nikon SX-1 Attachment Ring).



FA-QR29 adapter for Nikon SC-29	\$20
FA-QR200 adapter for Nikon SB-R200 (one).....	\$32
FA-QR200 Pair for Nikon SB-R200 (two).....	\$60

QUANTUM QFLASH ADAPTERS

FA-QRQ2

Use FA-QRQ2 for current generation Qflash units (T4d/T5d/T5d-R).

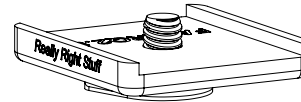

FA-QRQ2

FA-Q1

Use FA-Q1 for older Qflash units. The FA-Q1 is a non-QR adapter; to use with *SNAP QR* system, you must add FA-QR1 adapter.



FA-Q1

FA-QR-Q2 adapter for current Qflash (T4d/T5d/T5d-R).....	\$30
FA-Q1 adapter for older Qflash units.....	\$15

FA-QR-Bs

The QR base that is built into current *SNAP QR* mounts can also be purchased separately. This provides backwards compatibility with legacy RRS flash gear. Use the 1/4" socket on bottom to screw FA-QR-Bs onto legacy non-QR brackets (using the thumbwheel). The FA-QR-Bs fits all legacy Really Right Stuff flash brackets and flash accessories.

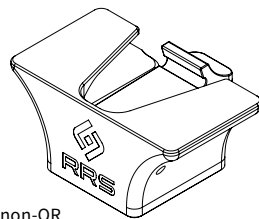

FA-QR-Bs..... \$39

GUARANTEE

ALL REALLY RIGHT STUFF BRAND PRODUCTS ARE GUARANTEED TO THE ORIGINAL PURCHASER TO BE FREE OF DEFECTS IN MATERIALS OR WORKMANSHIP FOR FIVE YEARS FROM THE DATE OF PURCHASE. PRODUCTS WILL BE REPAIRED OR REPLACED AT OUR OPTION.

®, ™, © 1990-2017 Really Right Stuff, LLC. All rights reserved.

FA-QRM MOUNT

Mount Strobes and Accessories to Rails

FA-QRM quick-release mount allows placement of strobes or other accessories directly onto any Really Right Stuff-style rail. Rotate grey thumbwheel to open clamping jaw, slide FA-QRM onto the rail, and lock it in place. Snap your accessory with installed adapter into *SNAP QR* mount. One FA-QRM is included with each WPF-QR2 flash bracket; purchase additional FA-QRM to mount multiple accessories.

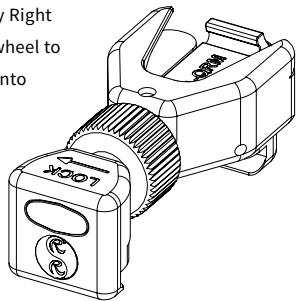

FA-QRM Mount..... \$48

COLD SHOES

FA-QRCS2 for SNAP QR™ Mounts

When you're not going to use a strobe cord (i.e., trigger the strobe wirelessly or with a sync cable), add our insulated FA-QRCS2 cold shoe so that you can mount your strobe into any *SNAP QR* mount. Compatible with Nikon SB-900 & Canon 580 EX II. Buy FA-QRCS2 Set for non-QR Really Right Stuff flash brackets/accessories.

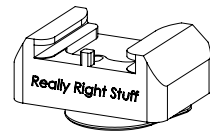

FA-CS3 for RRS Clamps

Your tripod with its Really Right Stuff head is an excellent lightstand. Add FA-CS3 cold shoe to mount your strobe directly in any Really Right Stuff clamp. Compatible with most hot shoe strobes.

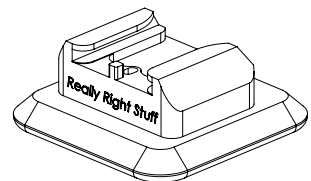

FA-QRCS2 cold shoe for SNAP QR™ mount..... \$32

FA-CS3 cold shoe for RRS Clamps..... \$32

TELESCOPING FLASH EXTENDER

FA-QREX2

Flash extension column extends from 6 to 10¼ inches. Snap fit into any *SNAP QR* mount. Excellent aid for positioning strobes for macro work.

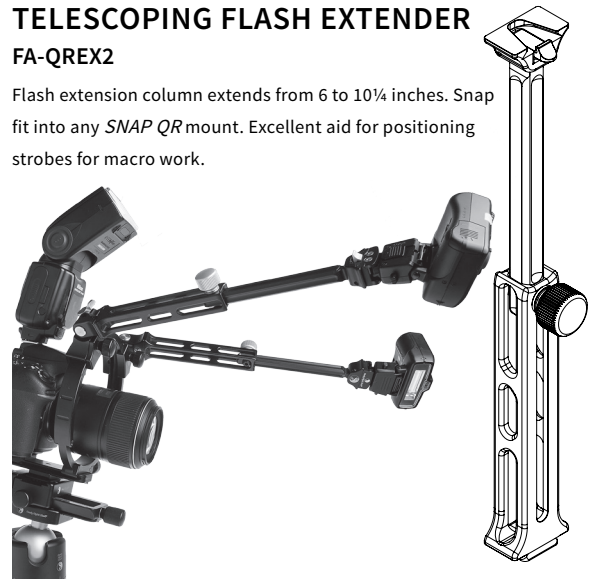

FA-QREX2 flash extender, adds 6" to 10¼"..... \$130

SPARE FLASH MOUNTS

B87-QRFM or B91-QRFM

A 2nd flash mount can be added to any RRS hoop/ring-style flash bracket. Choose from our tilting flash mounts (perfect for macro work—see image at left) or our "simple" non-tilting mounts (great for telephoto flash or any time tilt is not needed). Flash Mounts are model specific; choose the mount that fits your flash bracket. Each mount comes with one FA-QR1 strobe cord adapter.

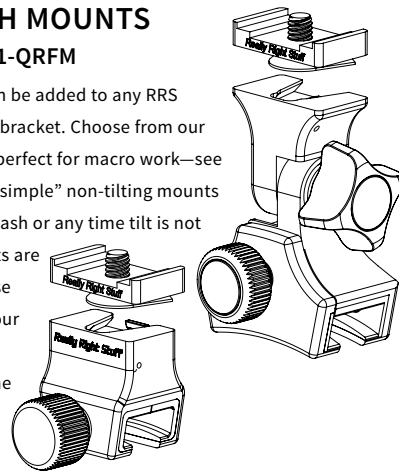

B87-QRFM flash mount for B87/FR-87..... \$170

B87-SFM simple flash mount for B87/FR-87..... \$90

B91-QRFM flash mount for B91/FR-91..... \$170

B91-SFM simple flash mount for B91/FR-91..... \$90